

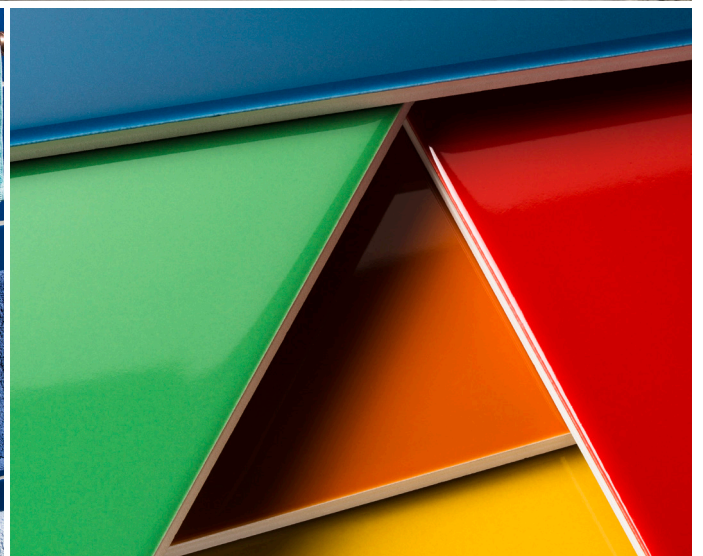

# Prismatics

Glazed Ceramic  
Wall Tiles

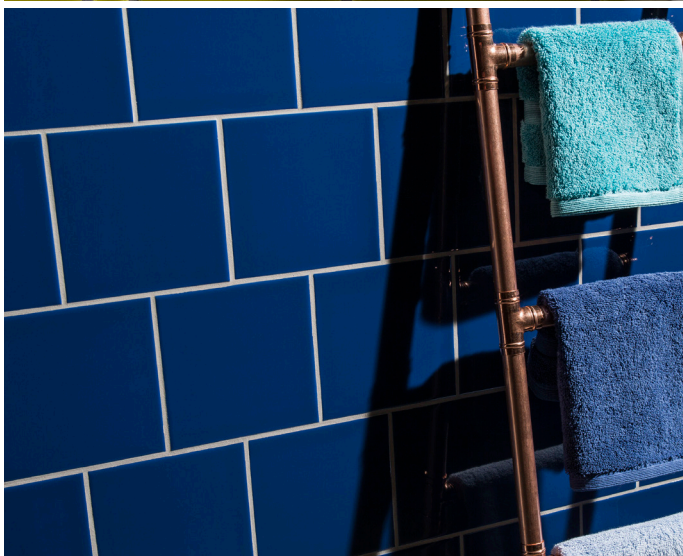

 **Prismatics** is available in **five sizes** plus fittings, perfectly designed for seamless installation.

#### Sizes

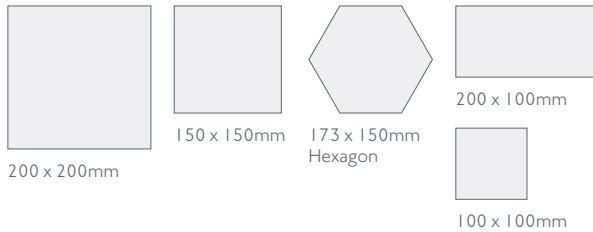

#### Thickness

All Sizes and Fittings = 6.5mm

#### Fittings

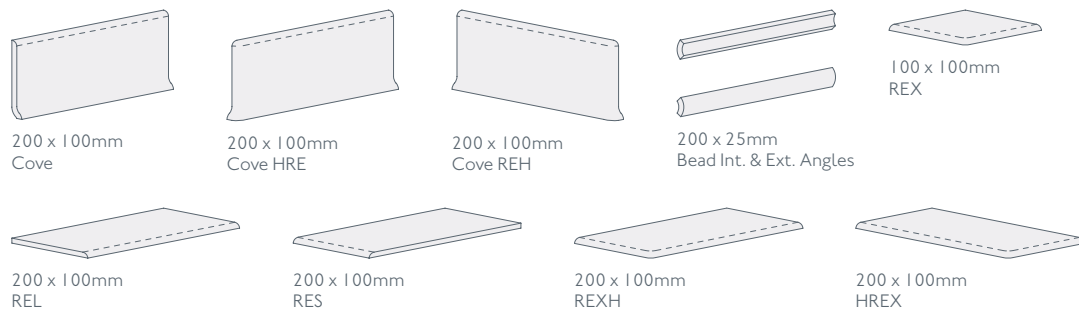

 **Two finishes**, combining form and function.

Examples below are not to scale but have been enlarged to show detail:



**Gloss**

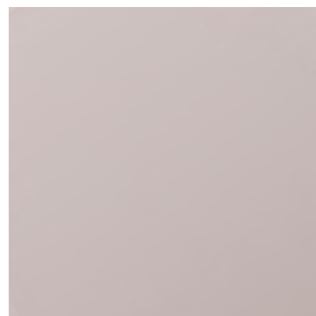

**Satin**

 **Sixty eight colours**, offering a colourful and vibrant palette.

Forty eight **gloss** and twenty **satin**.

For the most up-to-date availability information, please visit our website.



Black



Moleskin

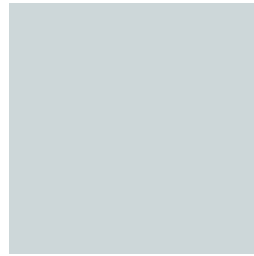

Shark

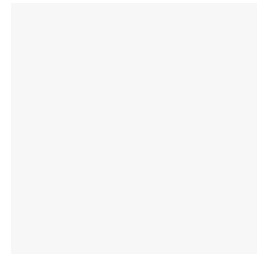

White

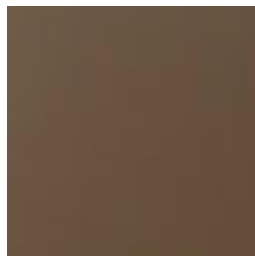

Russet



Truffle

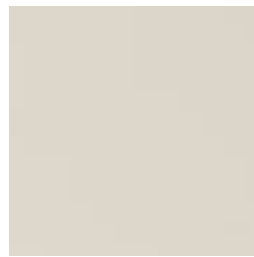

Old Lace

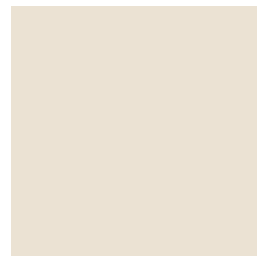

Magnolia

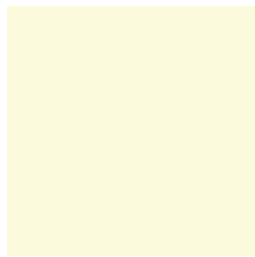

Vanilla



Goldcrest



Pumpkin



Cayenne



Lapis



Sky



Aqua

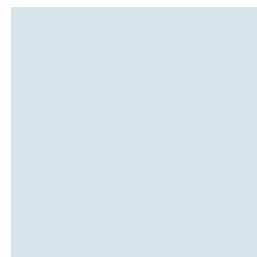

Harebell



Peacock



Sweet Pea

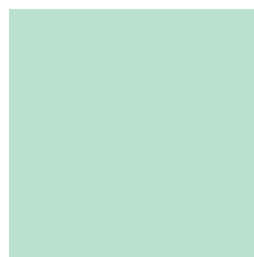

Peppermint



Willow

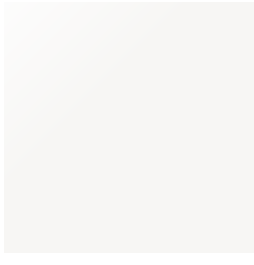

**White**



**Shark**



**Storm Grey**



**Hawk Grey**



**Mushroom**



**Old Lace**

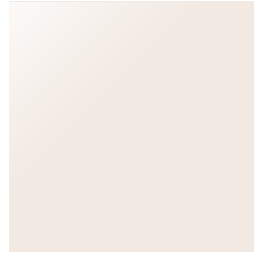

**Rice**

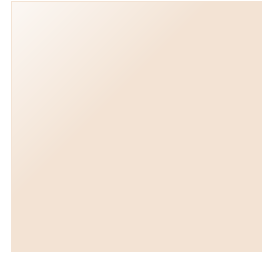

**Peach Sorbet**



**Ginger**



**Sandcastle**



**Victorian Cream**

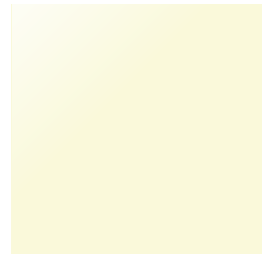

**Lemon Ice**

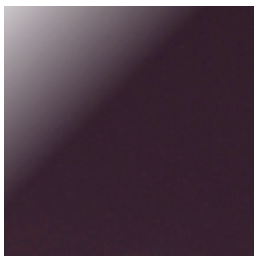

**Blackberry**



**Victorian Maroon**



**Magenta**



**Thistle**



**Victorian Blue**



**Midnight**



**Bluebell**



**Harebell**



**Victorian Green**



**Jungle**



**Olive**



**Chartreuse**

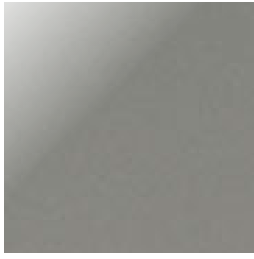

Ash



Elephant



Shadow



Black



Suede



Woodpigeon



Coffee



Cappuccino



Mimosa



Sun Haze



Goldcrest



Sunflower



Pumpkin



Tomato



Flame



Strawberry

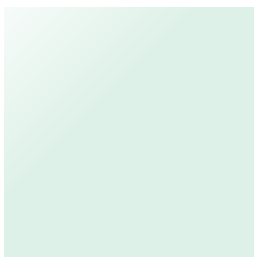

Mintwater



Duck Egg



Teal



Electric



Pistachio



Peppermint



Lagoon



Ocean Blue

## Availability

Colours	Codes	Finishes	Sizes	Fittings
			100 x 100mm 150 x 150mm 173 x 150mm Hexagon 200 x 100mm 200 x 200mm	200 x 100mm Cove 200 x 100mm Cove HRE 200 x 100mm Cove REH 200 x 25mm Bead Int. Angle 200 x 25mm Bead Ext. Angle 100 x 100mm REX 200 x 100mm REL 200 x 100mm RES 200 x 100mm REXH 200 x 100mm HREX
White	PRG1	Gloss	+ + + + +	+ + + + + + + + + +
Black	PRG6	Gloss	+ + + + +	+ + + + + + + + + +
Hawk Grey	PRG7	Gloss	+ + + + +	+ + + + + + + + + +
Cappuccino	PRG8	Gloss	+ + + + +	+ + + + + + + + + +
Woodpigeon	PRG9	Gloss	+ + + + +	+ + + + + + + + + +
Shark	PRG11	Gloss	+ + + + +	+ + + + + + + + + +
Teal	PRG16	Gloss	+ + + + +	+ + + + + + + + + +
Tomato	PRG19	Gloss	+ + + + +	+ + + + + + + + + +
Rice	PRG23	Gloss	+ + + + +	+ + + + + + + + + +
Storm Grey	PRG24	Gloss	+ + + + +	+ + + + + + + + + +
Thistle	PRG25	Gloss	+ + + + +	+ + + + + + + + + +
Duck Egg	PRG28	Gloss	+ + + + +	+ + + + + + + + + +
Harebell	PRG32	Gloss	+ + + + +	+ + + + + + + + + +
Bluebell	PRG33	Gloss	+ + + + +	+ + + + + + + + + +
Peach Sorbet	PRG36	Gloss	+ + + + +	+ + + + + + + + + +
Pistachio	PRG40	Gloss	+ + + + +	+ + + + + + + + + +
Peppermint	PRG43	Gloss	+ + + + +	+ + + + + + + + + +
Ocean Blue	PRG44	Gloss	+ + + + +	+ + + + + + + + + +
Mintwater	PRG45	Gloss	+ + + + +	+ + + + + + + + + +
Goldcrest	PRG48	Gloss	+ + + + +	+ + + + + + + + + +
Sun Haze	PRG50	Gloss	+ + + + +	+ + + + + + + + + +
Mimosa	PRG51	Gloss	+ + + + +	+ + + + + + + + + +
Lemon Ice	PRG53	Gloss	+ + + + +	+ + + + + + + + + +
Pumpkin	PRG55	Gloss	+ + + + +	+ + + + + + + + + +
Ash	PRG101	Gloss	+ + + + +	+ + + + + + + + + +
Chartreuse	PRG102	Gloss	+ + + + +	+ + + + + + + + + +
Old Lace	PRG103	Gloss	+ + + + +	+ + + + + + + + + +
Suede	PRG104	Gloss	+ + + + +	+ + + + + + + + + +
Lagoon	PRG105	Gloss	+ + + + +	+ + + + + + + + + +
Magenta	PRG106	Gloss	+ + + + +	+ + + + + + + + + +
Shadow	PRG107	Gloss	+ + + + +	+ + + + + + + + + +
Mushroom	PRG108	Gloss	+ + + + +	+ + + + + + + + + +
Sandcastle	PRG109	Gloss	+ + + + +	+ + + + + + + + + +
Jungle	PRG110	Gloss	+ + + + +	+ + + + + + + + + +
Electric	PRG111	Gloss	+ + + + +	+ + + + + + + + + +
Midnight	PRG112	Gloss	+ + + + +	+ + + + + + + + + +
Blackberry	PRG113	Gloss	+ + + + +	+ + + + + + + + + +
Elephant	PRG114	Gloss	+ + + + +	+ + + + + + + + + +
Coffee	PRG115	Gloss	+ + + + +	+ + + + + + + + + +
Ginger	PRG116	Gloss	+ + + + +	+ + + + + + + + + +
Olive	PRG117	Gloss	+ + + + +	+ + + + + + + + + +
Flame	PRG119	Gloss	+ + + + +	+ + + + + + + + + +
Strawberry	PRG120	Gloss	+ + + + +	+ + + + + + + + + +
Sunflower	PRG121	Gloss	+ + + + +	+ + + + + + + + + +
Victorian Cream	PRV2	Gloss	+ + + + +	+ + + + + + + + + +
Victorian Blue	PRV3	Gloss	+ + + + +	+ + + + + + + + + +
Victorian Maroon	PRV4	Gloss	+ + + + +	+ + + + + + + + + +
Victorian Green	PRV5	Gloss	+ + + + +	+ + + + + + + + + +
White	PRS12	Satin	+ + + + +	+ + + + + + + + + +
Black	PRS13	Satin	+ + + + +	+ + + + + + + + + +
Magnolia	PRS14	Satin	+ + + + +	+ + + + + + + + + +
Shark	PRS15	Satin	+ + + + +	+ + + + + + + + + +
Peppermint	PRS41	Satin	+ + + + +	+ + + + + + + + + +
Harebell	PRS42	Satin	+ + + + +	+ + + + + + + + + +
Willow	PRS73	Satin	+ + + + +	+ + + + + + + + + +
Vanilla	PRS76	Satin	+ + + + +	+ + + + + + + + + +
Truffle	PRS77	Satin	+ + + + +	+ + + + + + + + + +
Aqua	PRS80	Satin	+ + + + +	+ + + + + + + + + +
Lapis	PRS81	Satin	+ + + + +	+ + + + + + + + + +
Sweet Pea	PRS82	Satin	+ + + + +	+ + + + + + + + + +
Cayenne	PRS83	Satin	+ + + + +	+ + + + + + + + + +
Moleskin	PRS86	Satin	+ + + + +	+ + + + + + + + + +
Peacock	PRS87	Satin	+ + + + +	+ + + + + + + + + +
Russet	PRS91	Satin	+ + + + +	+ + + + + + + + + +
Old Lace	PRS93	Satin	+ + + + +	+ + + + + + + + + +
Sky	PRS94	Satin	+ + + + +	+ + + + + + + + + +
Pumpkin	PRS95	Satin	+ + + + +	+ + + + + + + + + +
Goldcrest	PRS96	Satin	+ + + + +	+ + + + + + + + + +

All sizes indicated are metric modular. All dimensions are in millimetres. All sizes shown are nominal.



Prismatics Black Satin 100 x 100mm

**Prismatics**, a range of sixty eight colours covering the entire colour spectrum. Suitable for any internal walling applications.

For more details on suitability, or advice on any technical issues, please contact our technical helpline below.

## Specification

### Size - All Sizes

Wall	Floor	Wet Barefoot	Material	Finish
Internal	-	-	Glazed Ceramic	Various

## Colour Notations

Colour	Code	NCS	LRV	Colour	Code	NCS	LRV
<b>Gloss</b>				Storm Grey	PRG24	3000-N	45
Ash	PRG101	5000-N	26	Strawberry	PRG120	2570-Y80R	12
Black	PRG6	9000-N	4	Suede	PRG104	3005-Y50R	40
Blackberry	PRG113	8010-R30B	5	Sun Haze	PRG50	1020-Y20R	64
Bluebell	PRG33	2030-R80B	38	Sunflower	PRG121	1070-Y	54
Cappuccino	PRG8	6010-Y50R	16	Teal	PRG16	6030-B	9
Chartreuse	PRG102	2060-G80Y	40	Thistle	PRG25	3030-R40B	27
Coffee	PRG115	5005-Y50R	24	Tomato	PRG19	1580-Y80R	15
Duck Egg	PRG28	2030-B30G	40	Victorian Blue	PRV3	5540-R70B	6
Electric	PRG111	4050-B10G	13	Victorian Cream	PRV2	0907-Y30R	73
Elephant	PRG114	7005-R80B	12	Victorian Green	PRV5	8010-G30Y	7
Flame	PRG119	3060-Y60R	18	Victorian Maroon	PRV4	6030-R	7
Ginger	PRG116	3020-Y30R	36	White	PRG1	0500-N	86
Goldcrest	PRG48	2060-Y10R	39	Woodpigeon	PRG9	4005-Y80R	32
Harebell	PRG32	1010-R90B	67	<b>Satin</b>			
Hawk Grey	PRG7	4502-B	29	Aqua	PRS80	2030-B50G	41
Jungle	PRG110	4040-G20Y	19	Black	PRS13	8500-N	6
Lagoon	PRG105	4020-B90G	26	Cayenne	PRS83	2070-Y80R	16
Lemon Ice	PRG53	0507-Y	84	Goldcrest	PRS96	2070-Y10R	36
Magenta	PRG106	3040-R20B	20	Harebell	PRS42	1010-R70B	66
Midnight	PRG112	5040-R70B	8	Lapis	PRS81	3050-R80B	17
Mimosa	PRG51	1020-Y	68	Magnolia	PRS14	1510-Y40R	59
Mintwater	PRG45	0510-G90Y	85	Moleskin	PRS86	7005-R80B	12
Mushroom	PRG108	3005-Y50R	40	Old Lace	PRS93	1505-G90Y	64
Ocean Blue	PRG44	5030-B50G	15	Peacock	PRS87	5030-B50G	15
Old Lace	PRG103	2005-Y20R	55	Peppermint	PRS41	1515-G	57
Olive	PRG117	4040-G50Y	22	Pumpkin	PRS95	2070-Y40R	26
Peach Sorbet	PRG36	0907-Y70R	71	Russet	PRS91	6010-Y50R	16
Peppermint	PRG43	1515-G	57	Shark	PRS15	2002-G50Y	57
Pistachio	PRG40	2030-G50Y	47	Sky	PRS94	3030-R90B	29
Pumpkin	PRG55	2070-Y40R	26	Sweet Pea	PRS82	2050-G20Y	33
Rice	PRG23	1005-Y80R	69	Truffle	PRS77	3010-Y80R	38
Sandcastle	PRG109	2010-Y40R	51	Vanilla	PRS76	1010-G90Y	71
Shadow	PRG107	8005-R80B	7	White	PRS12	0603-Y80R	81
Shark	PRG11	2002-G50Y	57	Willow	PRS73	1010-G20Y	69

**Note:** These results are from Johnson Tiles' internal test reports and are to be used for guidance only. LRV: Light Reflectance Value (Reflectance Y).

1	Front Cover Image 1: <b>Prismatics Chartreuse Gloss 200 x 100mm</b>
2	Front Cover Image 2: <b>Prismatics Victorian Blue Gloss 150 x 150mm</b>
3	Front Cover Image 3: <b>Prismatics Victorian Blue, Sunflower, Strawberry, Pumpkin and Jungle Gloss</b>

## Samples

Tel: +44 (0)1782 524043  
 Fax: +44 (0)1782 577379  
 Email: [samples@johnson-tiles.com](mailto:samples@johnson-tiles.com)

## Technical Helpline

Tel: +44 (0)1782 524111  
 Fax: +44 (0)1782 577379  
 Email: [techadvice@johnson-tiles.com](mailto:techadvice@johnson-tiles.com)

