

[INCLUSIONI]
classico

INSPIRED BY
NATURE, CREATED
WITH ART



GIGACER®

THE TIMELESS POETRY OF COLOUR / LA POESIA SENZA TEMPO DEL COLORE

Inspired by the force of the nature, **Inclusioni** is an encounter between contemporary aesthetics and timeless elegance. Porcelain stoneware flakes produced under the skilful control of our laboratory technicians, deposited on the surface and incorporated, create refined and material surfaces, with a tangible and three-dimensional effect.

Just like minerals, refined and amalgamated by the currents of rivers, seas, winds and sedimentations make up the harmony of nature, Inclusioni inserts stones and sands into its thickness, forming a single, very hard and smooth body over time, in which colours mixed to each other and the stones adapt their shape.

In the **Classico** collection, new shades with a strong visual impact model and condition the surfaces. The timeless expressiveness of color meets the potential of the deep and material thickness, overflowing with perspectives and meanings: the full-body ceramic confirms its versatility, paving the way for multiple applications. Between vintage accents and classical references, **Inclusioni Classico's** eclectic character adapts to different styles of interior design, fitting with elegance and personality into modern and contemporary settings, to whom it lends a timeless and refined elegance.

The combination of the different color variations with materials such as metal, wood and fabrics generates special accents, expanding the creative possibilities and giving life to new architectures with timeless charm.

Ispirata dalla forza paziente della natura, **Inclusioni** è un incontro tra estetica contemporanea ed eleganza senza tempo. Scaglie in gres porcellanato prodotte sotto il sapiente controllo dei tecnici del nostro laboratorio, deposte sulla superficie e inglobate, danno vita a superfici materiche e raffinate, dall'effetto tangibile e tridimensionale.

Come i minerali raffinati e amalgamati dalle correnti dei fiumi e dei mari, dai venti e dalle sedimentazioni compongono l'armonia della natura, allo stesso modo Inclusioni inserisce i sassi e le sabbie nel suo spessore, formando nel tempo un corpo unico, durissimo e levigato in cui i colori si uniscono e le pietre adeguano la loro forma.

Nella collezione **Classico**, nuove cromie dal forte impatto visivo configurano le superfici, le modellano e le condizionano. L'espressività senza tempo del colore incontra le potenzialità dello spessore pieno e materico, denso di prospettive e significati: il materiale a tutta massa conferma la sua versatilità, aprendo la strada a molteplici applicazioni.

Tra accenti vintage e richiami classicheggianti, il carattere eclettico di **Inclusioni Classico** si adatta a diversi stili di interior design, inserendosi con eleganza e personalità in contesti moderni e contemporanei, ai quali conferisce un'eleganza intramontabile.

L'abbinamento delle diverse varianti di colore e l'accostamento con altri materiali come il metallo, il legno e i tessuti crea accenti particolari ampliando le possibilità creative e dando vita a nuove architetture dal fascino senza tempo.



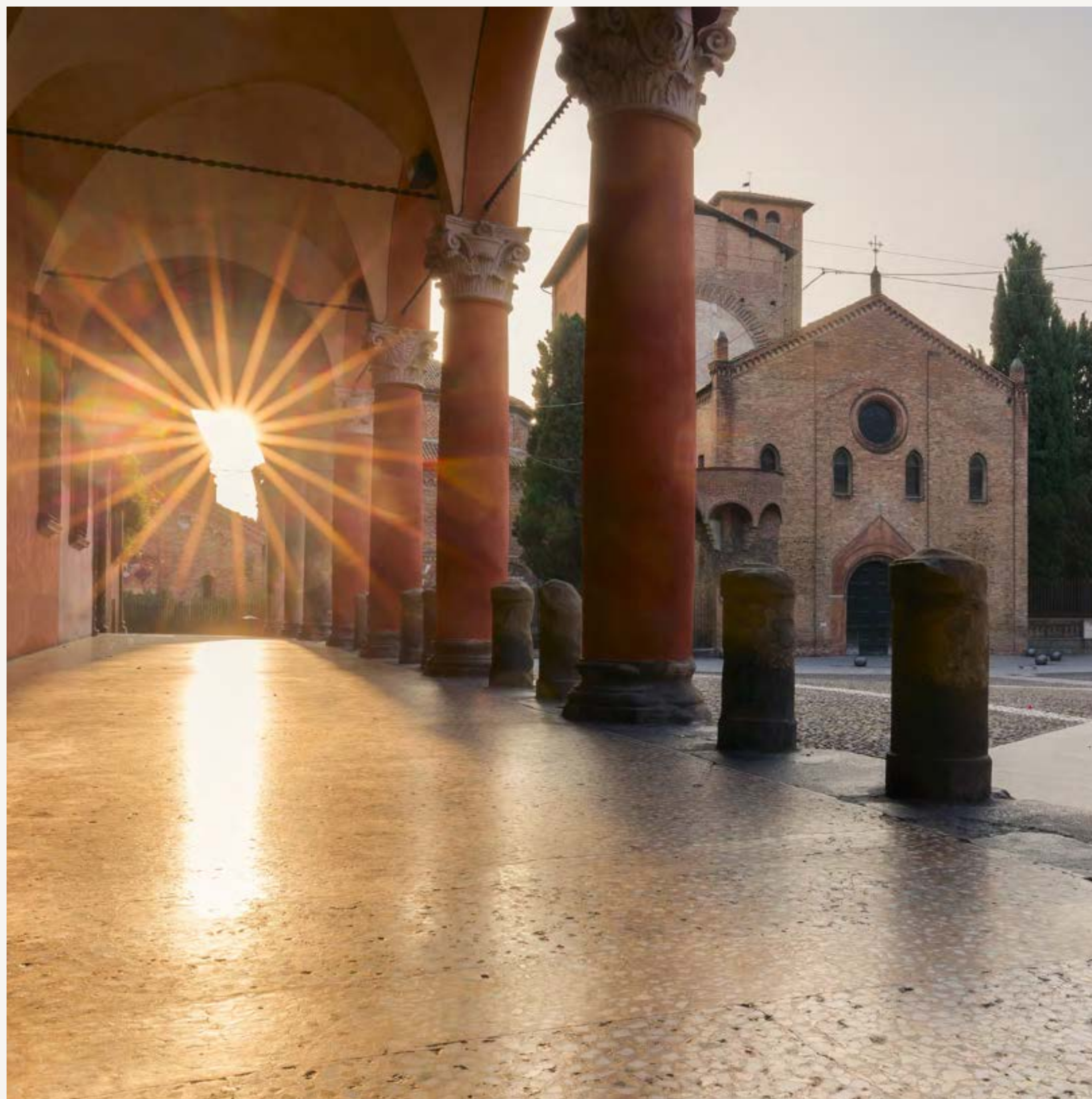

Colour, between classic aesthetics and contemporary design / Il colore, tra estetica classica e progettualità contemporanea

INDEX INDICE

2	intro
4	sizes and thicknesses formati e spessori
5	colours colori
14	projects progetti
25	product guide guida prodotto

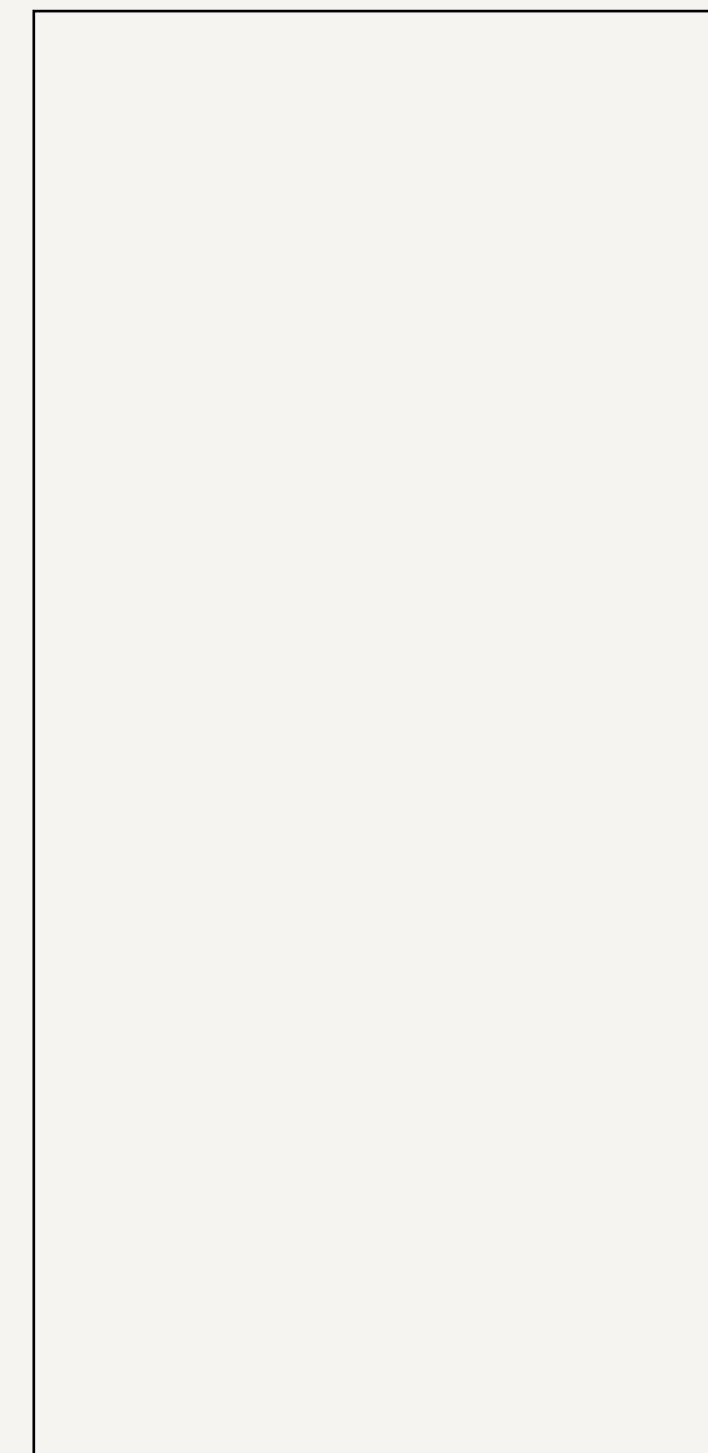
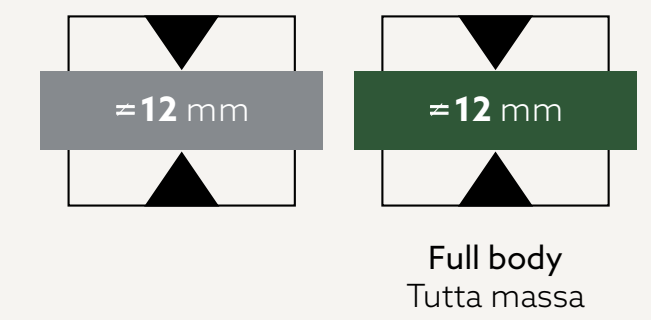

120x250
48"x100"
Full body not rectified / rectified
Tutta massa non rettificato / rettificato

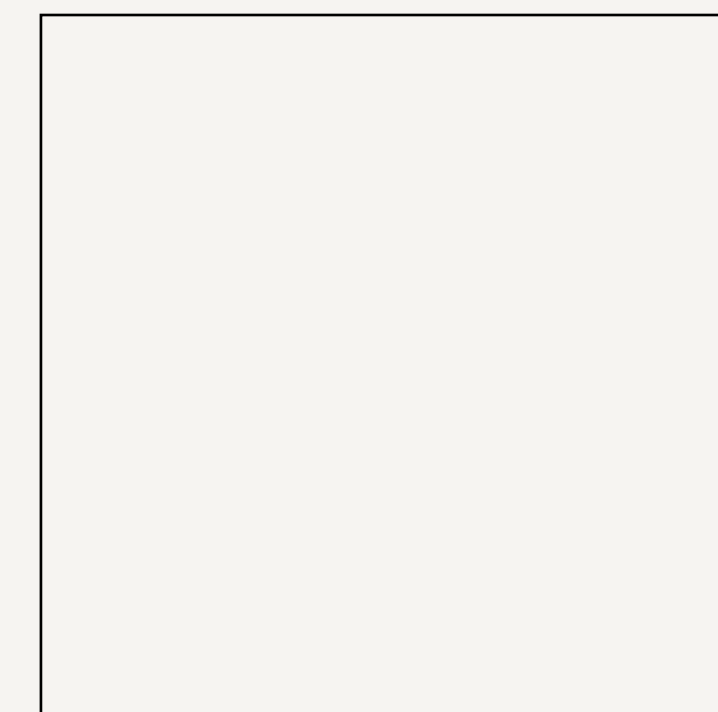

120x120
48"x48"

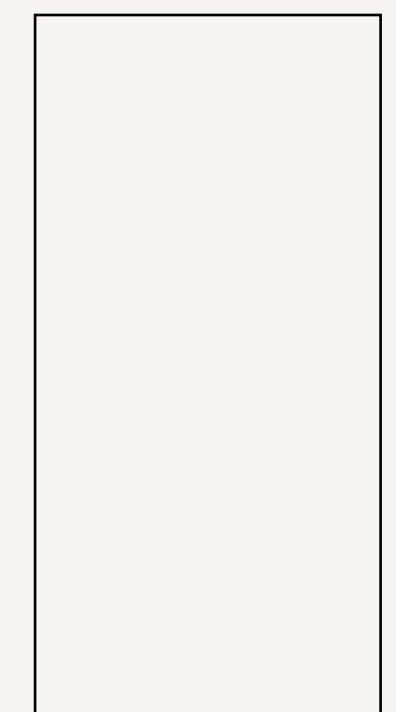

60x120
24"x48"

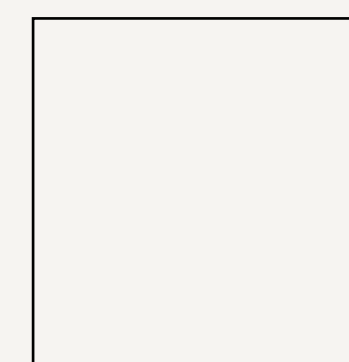

60x60
24"x24"

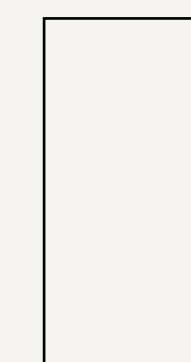

30x60
12"x24"



30x30
12"x12"



The products with the **GIGACER SERVICE** label will be manufactured only upon specific request and they will be quoted where necessary. / Gli articoli con il marchio **GIGACER SERVICE** saranno prodotti solo su specifica richiesta e quotati ove necessario.

AVORIO
MAT / LEVIGATO

GRIGIO
MAT / LEVIGATO

TERRA
MAT / LEVIGATO

NERO
MAT / LEVIGATO

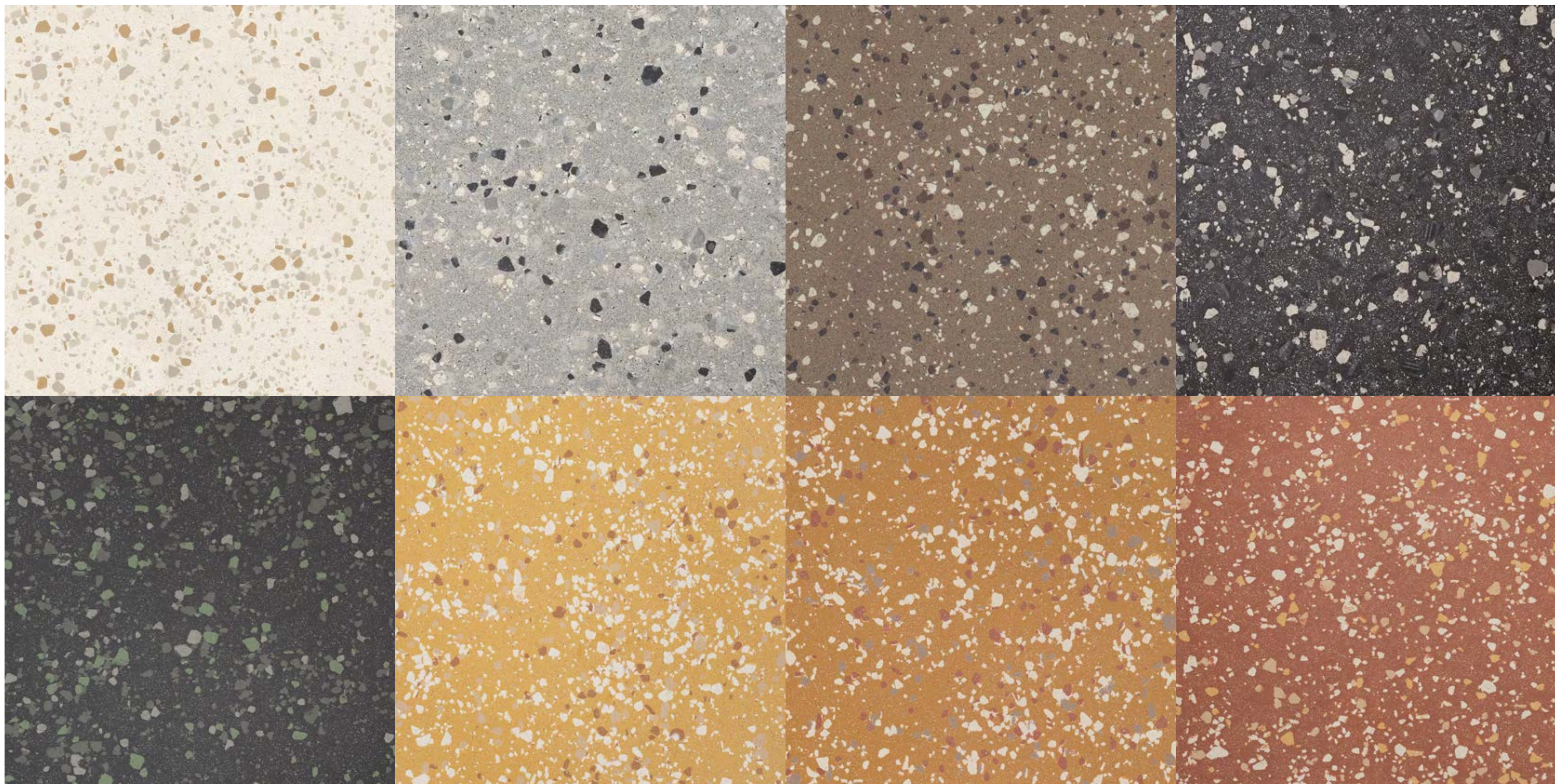

MAT / LEVIGATO
#12 mm

NERO GIADA
MAT / LEVIGATO

OCRA
MAT / LEVIGATO

AMBRA
MAT / LEVIGATO

ROSSO
MAT / LEVIGATO

The following pictures portray a portion of the slabs only. / Le immagini rappresentate riproducono una porzione delle lastre.



AVORIO



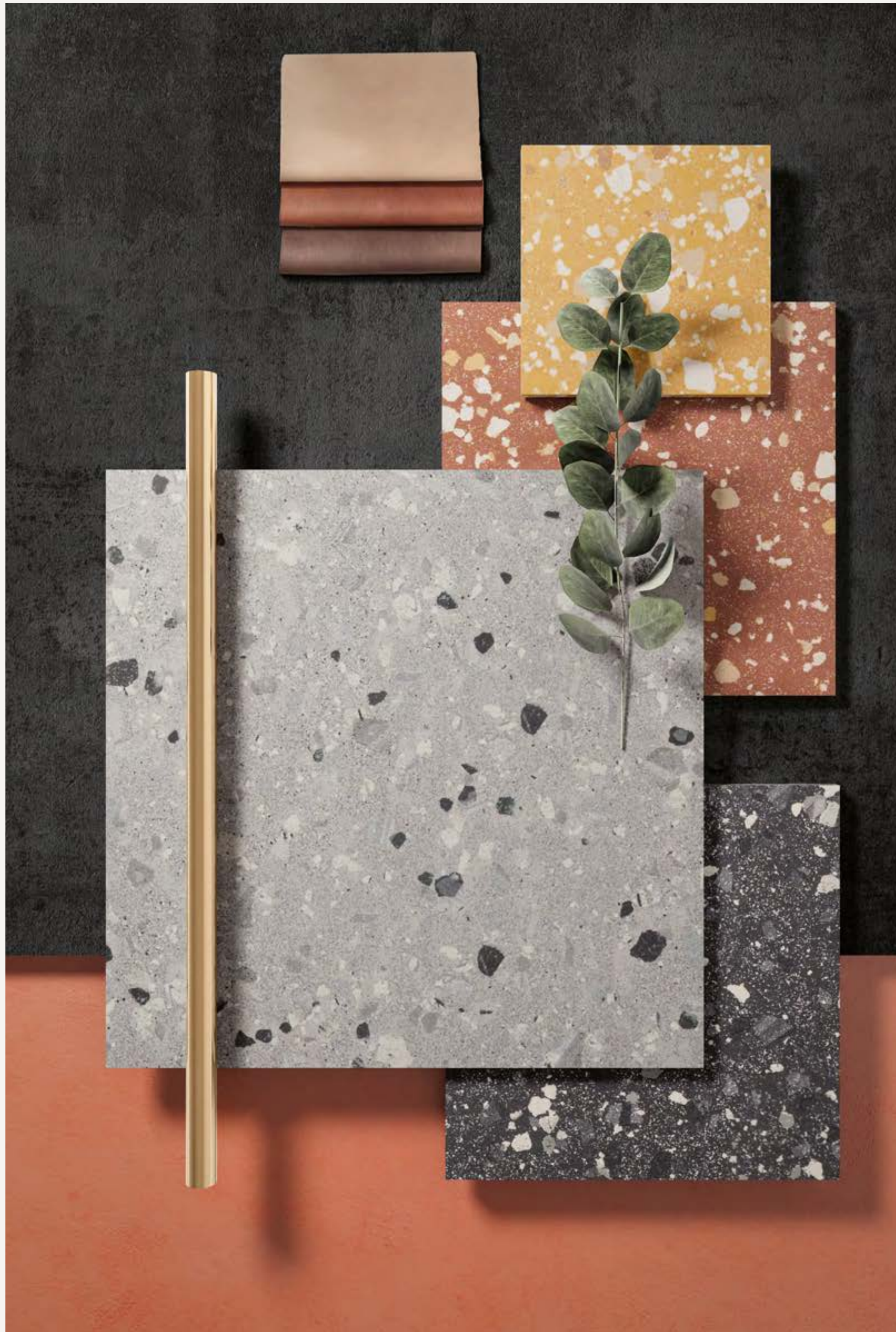

GRIGIO





TERRA

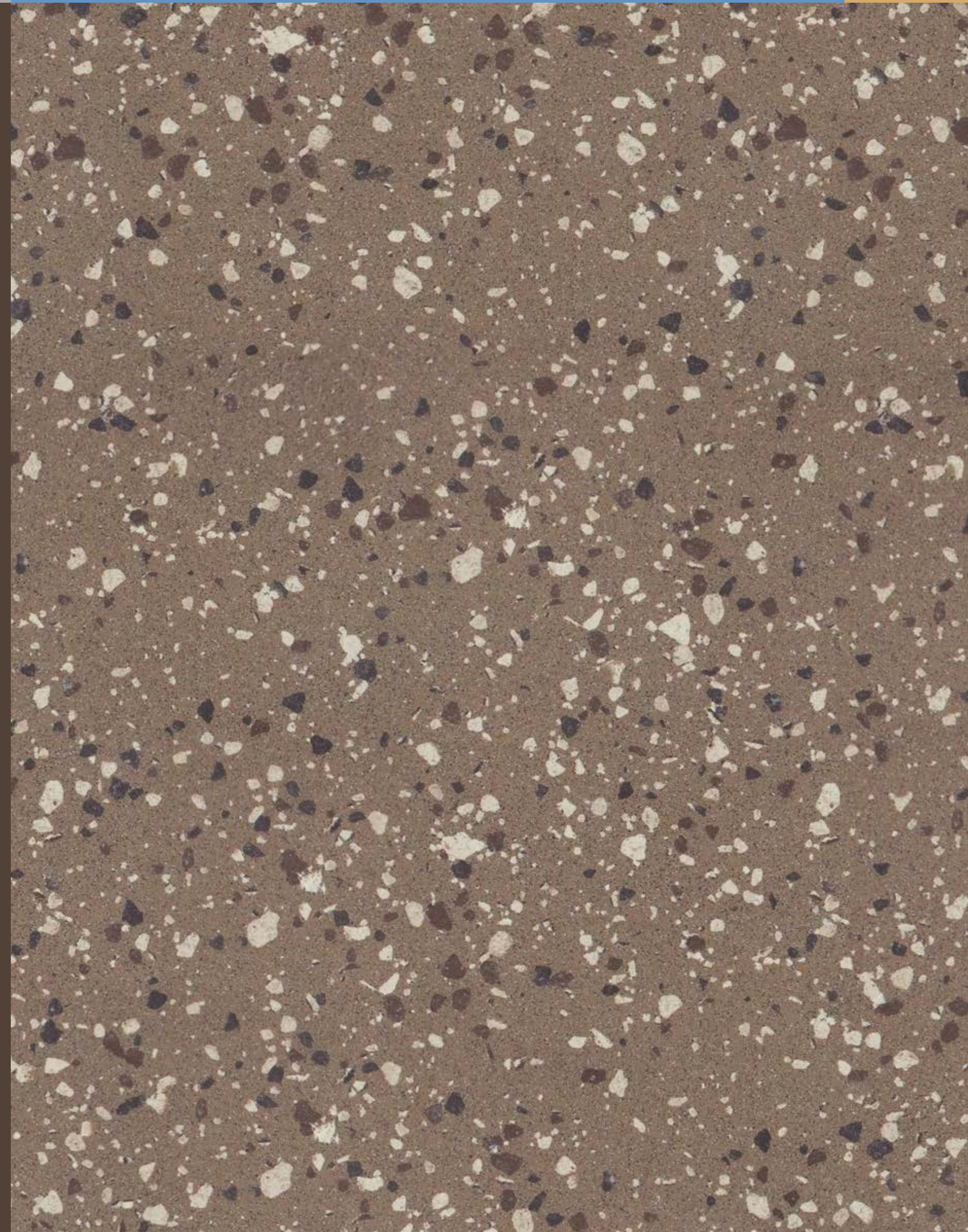



NERO





NERO GIADA





OCRA





AMBRA





ROSSO



PROJECTS PROGETTI

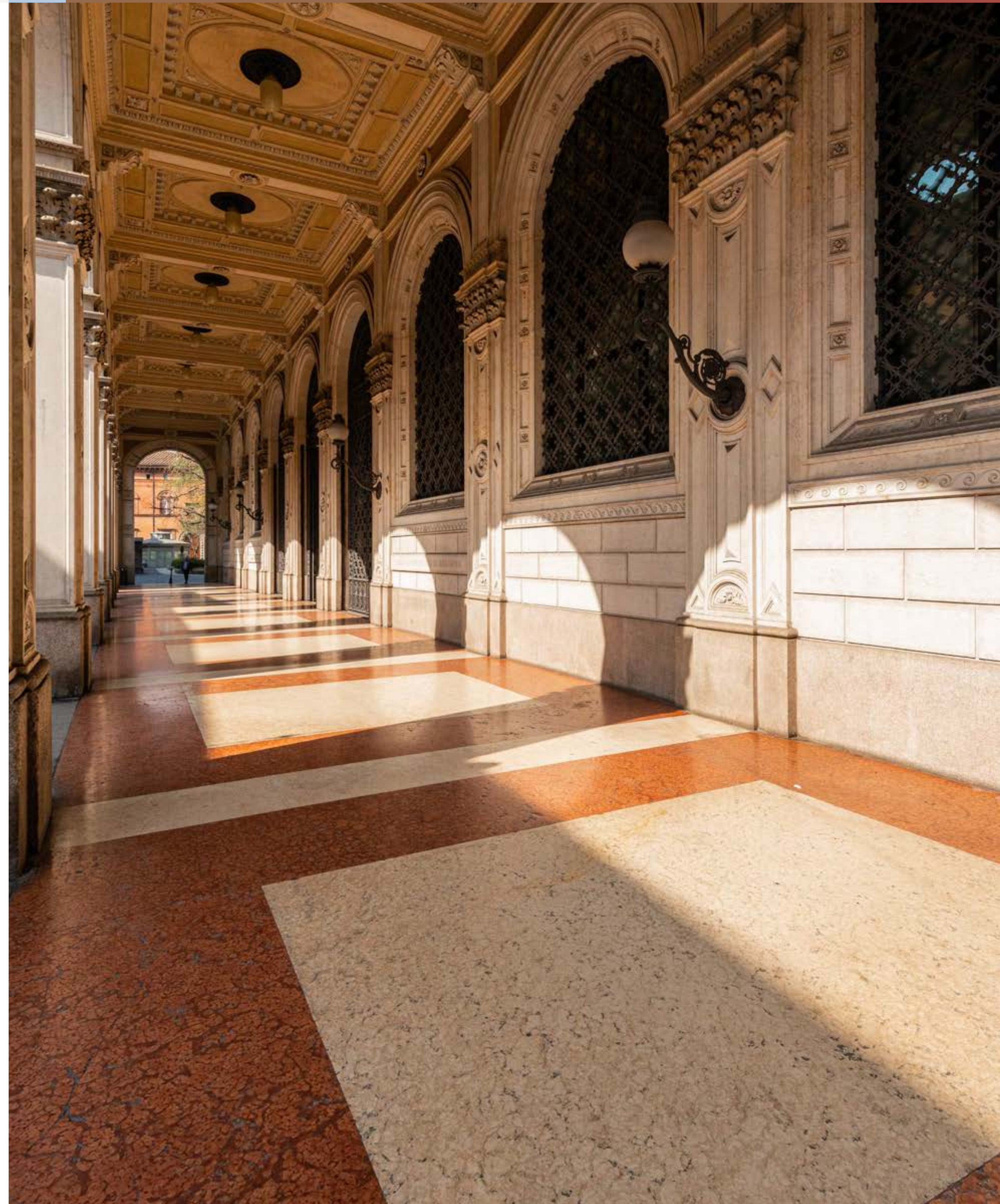



FLOOR | PAVIMENTO
Inclusioni Classico Rosso, Ocra, Nero, Grigio Mat #12 mm Gigacer Service
BLOCKS | CUBI
Inclusioni Classico Nero, Grigio Mat #12 mm Gigacer Service



2

2. / 3.
 FLOOR | PAVIMENTO
Inclusioni Classico Nero Mat 60x120 / 24"x48" / ≠12 mm
 STAIRS | SCALA
Inclusioni Classico Nero Mat Full Body / Tutta massa ≠12 mm Gigacer Service
 WALL | PARETE
Light blend mix 15x60 / 6"x24" / ≠6 mm



3



FLOOR | PAVIMENTO
Inclusioni Classico Nero Giada Levigato 120x120 / 48"x48" / #12 mm



FLOOR | PAVIMENTO
Inclusioni Classico Nero Giada Levigato 120x120 / 48"x48" / #12 mm



5

5. / 6.

FLOOR | PAVIMENTO

Inclusioni Classico Ocra Mat 60x60 / 24"x24" / ≠12 mm, **Ambra Mat** 30x30 / 12"x12" / ≠12 mm
 Gigacer Service, **Avorio Mat** 30x60 / 12"x24" / ≠12 mm



6



7



8

7. / 8.

FLOOR | PAVIMENTO

Inclusioni Classico Rosso Mat 120x120 / 48"x48" / ≠12 mm

WASH BASIN "DOUBLE" | LAVABO "DOUBLE"

Inclusioni Classico Rosso Mat 50 x 180 / 19 1/2" x 71" / Full body / Tutta massa / ≠12 mm Gigacer Service

WALL | PARETE

Inclusioni Classico Rosso Mat 120x120 / 48"x48" / ≠12 mm

Concrete White 120x250 / 48"x100" / ≠6 mm



WASH BASIN "DOUBLE" | LAVABO "DOUBLE"
Inclusioni Classico Rosso Mat 50 x 180 / 19 1/2" x 71" / Full body / Tutta massa / #12 mm Gigacer Service
WALL | PARETE
Concrete White 120x250 / 48"x100" / #6 mm



9



10

9. / 10.

FLOOR | PAVIMENTO

Inclusioni Classico Terra Mat 120x120 / 48"x48" / ≠12 mm

Inclusioni Classico Terra, Avorio Mat 30x30 / 12"x12" / ≠12 mm Gigacer Service

KITCHEN TOP | TOP CUCINA

Inclusioni Classico Terra Mat Full body / Tutta massa / ≠12 mm Gigacer Service

WALL | PARETE

Concrete White Mosaic Wall 30x30 / 12"x12" / ≠4.8 mm



11

11. / 12.

FLOOR | PAVIMENTO

Inclusioni Classico Ocra Mat 120x120 / 48"x48" / ≠12 mm, **Avorio Mat** 60x120 / 24"x48" / ≠12 mm, **Terra Mat** 120x120 / 48"x48" / ≠12 mm

TABLE | TAVOLO

Inclusioni Classico Terra Levigato Full body / Tutta massa / ≠12 mm Gigacer Service



12



16

16. / 17.

FLOOR | PAVIMENTO

Inclusioni Classico Avorio, Nero Levigato 120x120 / 48"x48" / ≠12 mm

Inclusioni Classico Avorio, Nero Levigato 30x120 / 12"x48" / ≠12 mm Gigacer Service

Inclusioni Classico Avorio, Nero Levigato 30x30 / 12"x12" / ≠12 mm Gigacer Service



17

PRODUCT GUIDE GUIDA
PRODOTTO

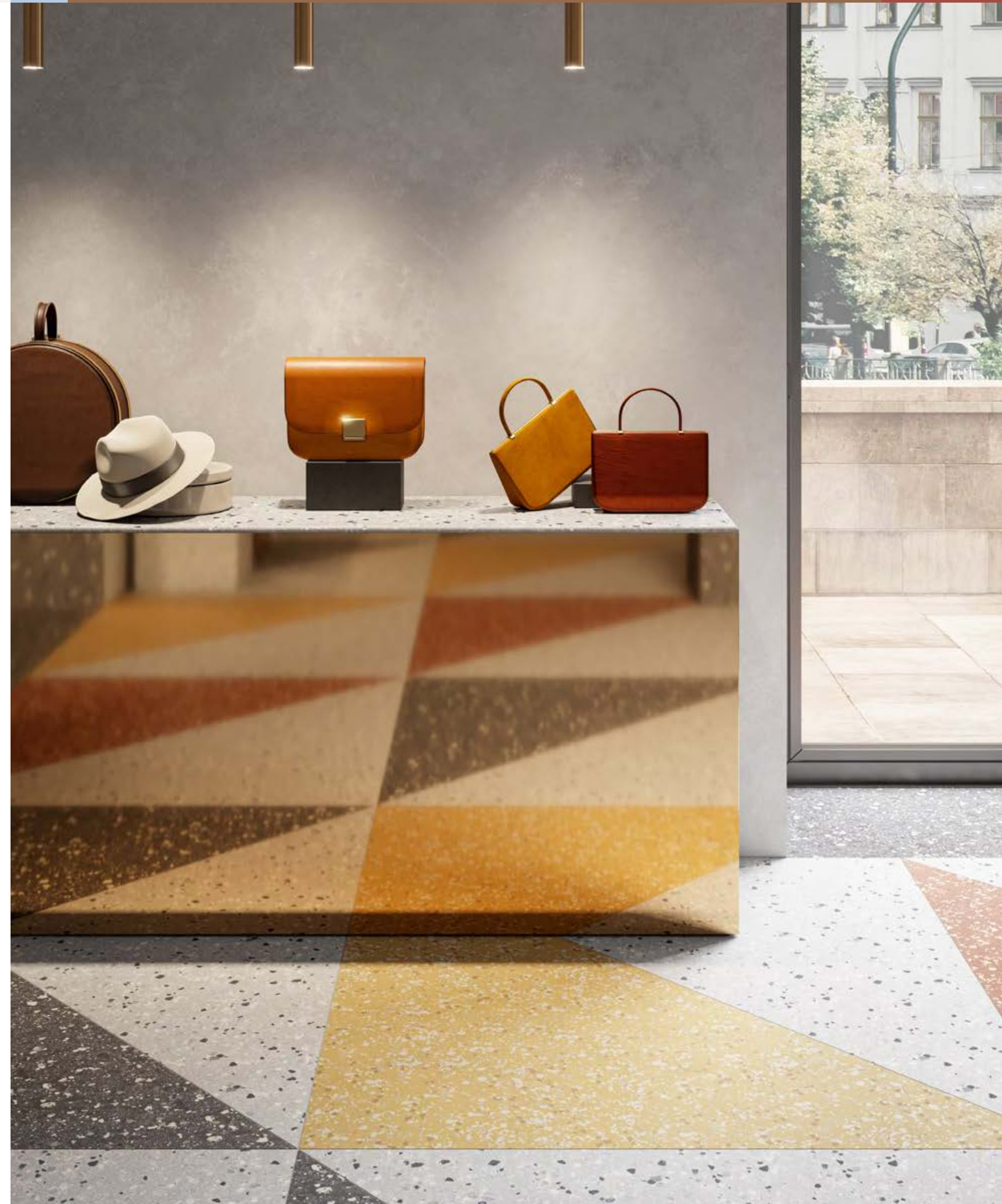

SUSTAINABLE THINKING SOSTENIBILITÀ

WE PAY CLOSE ATTENTION TO:

- the safety and comfort of our production staff;
- the respect for the environment in and around the factory;
- the safety of tile layers in the building site, which is guaranteed by the specially designed packaging that makes movement easier and that is completely recyclable.

We manufacture large porcelain slabs thanks to the application of advanced technologies, in accordance with the current European environmental standards (and often with even better results). For this reason the engines are installed in soundproof areas, the lighting around the production area is low emission, there is an environmental monitoring in real time, the complete packaging (sidepack) uses minimum quantities of cardboard and, however, the material used for packaging is completely recyclable and glueless.

TECHNOLOGICAL INNOVATION / AN INTELLIGENT PRODUCTION PROCESS.

GIGACER production process starts from large porcelain slabs, size 120x250 e 120x120 cm, homogeneous multilayer. The slabs can then be cut in many other submultiples and worked again to get different finishes, preserving their top quality and aesthetic features.

These homogeneous multilayer porcelain slabs show superior technical and aesthetic characteristics thanks to a highly innovative technology. The equipment has been realized on purpose to manufacture large sizes and uses an innovative technology called "CONTINUA". This technology foresees a pre-compacting phase before pressing, that allows to achieve special decorative effects without using glazes, but only distributing the porcelain mixed powders on the body. The thickness of the manufactured slabs are 12 mm and 6 mm.

CURIAMO CON PARTICOLARE ATTENZIONE:

- la sicurezza ed il comfort del personale addetto alla produzione;
- il rispetto dell'ambiente in cui sorge lo stabilimento;
- la sicurezza del personale sul cantiere, garantita da imballaggi studiati per facilitare la movimentazione e completamente riciclabili.

Produciamo grandi lastre ceramiche grazie all'applicazione di tecnologie all'avanguardia, nel rispetto (spesso anche in senso molto migliorativo) delle vigenti normative europee sull'ambiente. Per questo i macchinari si trovano in ambienti insonorizzati, l'illuminazione della linea produttiva è a basso regime, esiste un monitoraggio ambientale in tempo reale, il sistema di imballaggio - sidepack - prevede, prima della pressatura, l'utilizzo di quantità di cartone minime e comunque i materiali dell'imballo sono completamente riciclabili e privi di colle.

INNOVAZIONE TECNOLOGICA / UN PROCESSO PRODUTTIVO INTELLIGENTE.

Il processo produttivo di GIGACER prevede la preparazione preliminare di due formati principali, grandi lastre in gres porcellanato 120x250 e 120x120 cm, multistrato o tutta massa, che possono essere successivamente tagliate e modificate a freddo in molteplici altri formati e superfici mantenendo la massima garanzia di requisiti tecnici qualitativi ed estetici.

Questa serie di lastre caratterizzate da superiori prerogative tecniche ed estetiche viene prodotta in gres porcellanato a tutta massa multistrato con una tecnologia assolutamente innovativa. L'impianto è stato progettato appositamente per produrre grandi formati e utilizza la tecnologia definita "CONTINUA" che prevede prima della pressatura, una fase di precompattazione della lastra multistrato a tutta massa che permette di ottenere speciali effetti decorativi senza ricorrere all'uso di smalti, ma solo con la distribuzione di impasti porcellanati colorati di qualità. Gli spessori delle lastre prodotte sono di 12 mm e 6 mm.

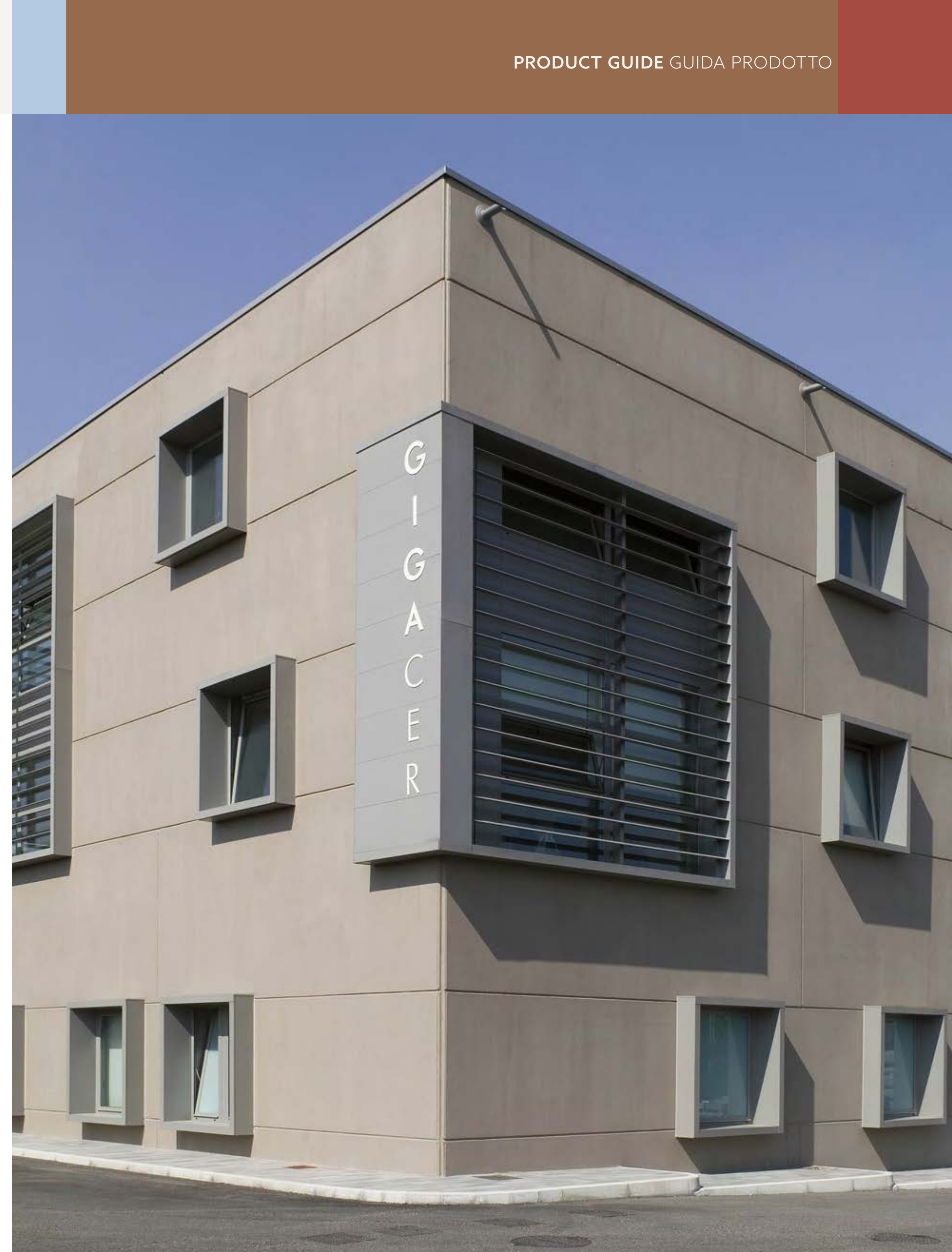

EDGE AND WORKTOP MACHINING LAVORAZIONI BORDI E TOP

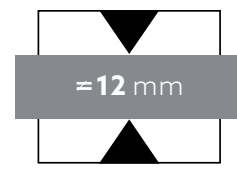

EDGE MACHINING LAVORAZIONI BORDI

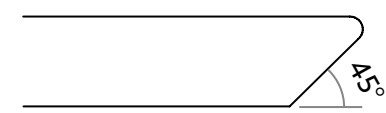

A Reverse angled ridge 45°
Costa a profilo inclinato

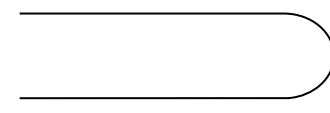

C Full rounded ridge
Costa a toro

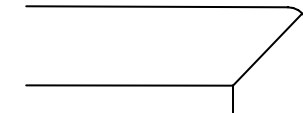

E L-shaped squared ridge
Veletta a vista

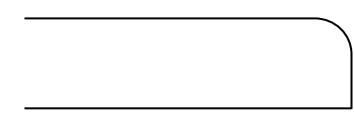

B Rounded straight ridge
Costa pari a tondino

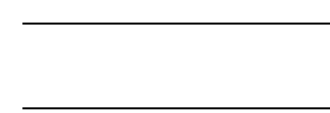

D Double straight squared ridge
Costa pari lati a vista

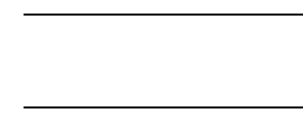

F Raw edge
Taglio grezzo



WORKTOP MACHINING LAVORAZIONI TOP

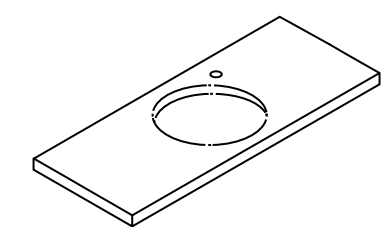

Raw circular or shaped hole
Foro grezzo circolare o sagomato

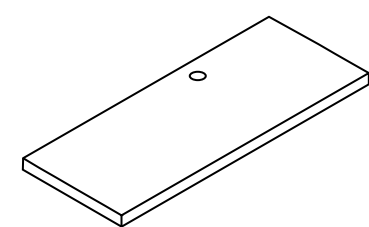

Mixer hole
Foro per miscelatore

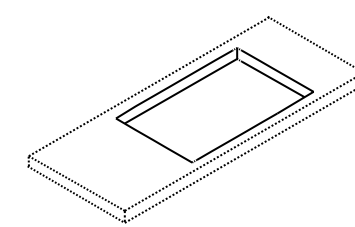

Raw rectangular hole
Foro grezzo rettangolare

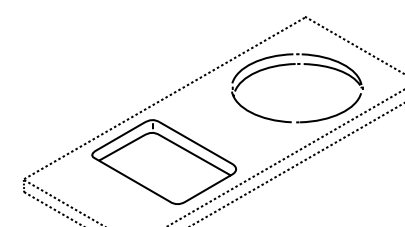

Satin hole
Foro satinato

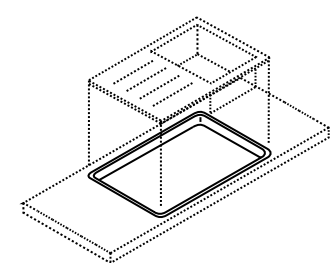

Top-aligned hole
Foro filo top

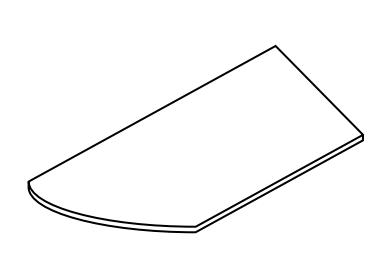

Radiused final
Terminale raggato

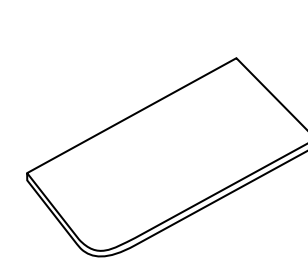

Radiused corner
Angolo raggato

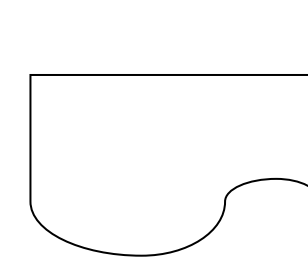

Shaping raw
Sagomatura grezza



**SPECIAL TRIMS
PEZZI SPECIALI**

SKIRTING BATTISCOPIA

Battiscopa 60
≈12 mm

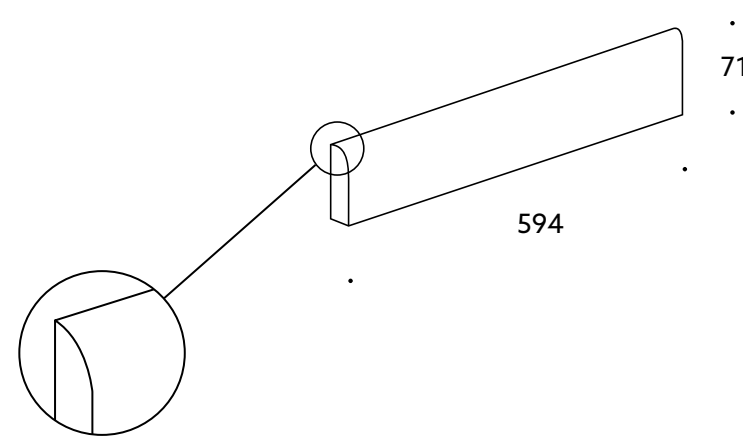

COSTA RETTA STEPTREADS GRADONI COSTA RETTA

Costa retta 60
≈12 mm

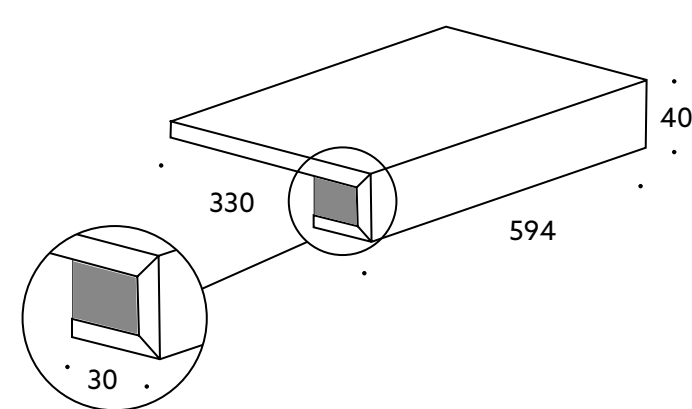

Costa retta 120
≈12 mm

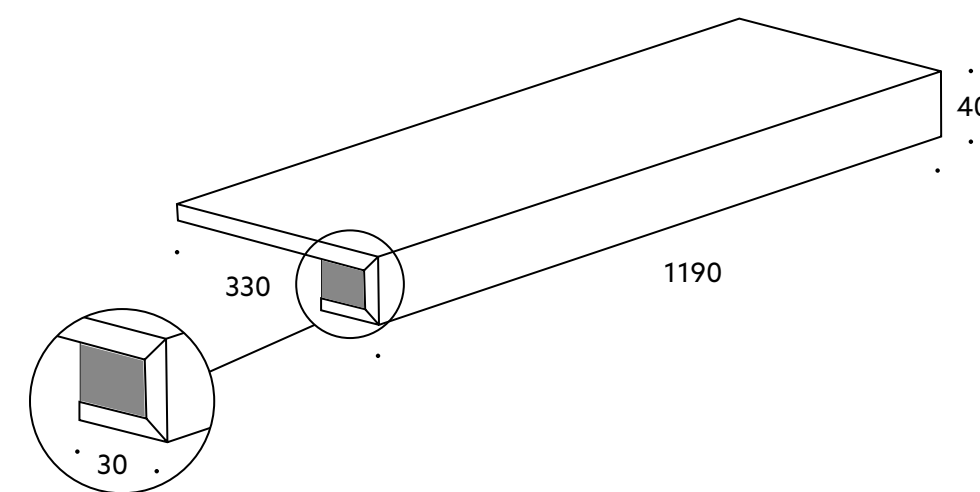

USE

- Steptreads for stairs
- Windowsills
- Terraces and balconies edge finish
- Poolside
- Indoor or outdoor

UTILIZZO

- Gradini per scale
- Davanzali
- Finitura terrazze e balconi
- Bordo piscine
- Interno o esterno

(!)
All sizes are in millimetres
Tutte le misure sono in millimetri

**SPECIAL SERVICES
SERVIZI SPECIALI**



Gigacer Service is the firm's made to measure working service offered on all products. It enables slabs to be cut, perforated, polished and generally adapted to the individual project in line with the requisites of a specific client design. In this way the ceramic slabs can be used both to create decor elements and to personalise or adjust slab dimensions to flooring or decor designs. In this way the ceramic slabs can be matched with, or even identical to, the kitchen worktop, flights of steps, the bathroom worktop and even the basin in an infinity of possible forms and dimensions. Each single piece can be made in accordance with designers' instructions and technical drawings.

Gigacer Service è il servizio di lavorazioni su misura offerto da Gigacer su tutti i suoi prodotti. Consente di tagliare, forare, lucidare e in generale adattare le lastre al singolo progetto, seguendo le indicazioni di uno specifico disegno del cliente. In questo modo le lastre ceramiche possono essere utilizzate sia per realizzare elementi d'arredo, sia per personalizzare o adeguare al progetto le dimensioni di lastre per pavimento o rivestimento. Il pavimento o il rivestimento potrà così essere abbinato o addirittura identico al top cucina, ai gradini della scala, al top bagno o anche allo stesso lavabo, in una infinità di forme e dimensioni. Il pezzo unico viene realizzato anche seguendo le indicazioni e il disegno tecnico del progettista.

CHANGES ON REQUEST MODIFICHE SU RICHIESTA

It is possible to require the feasibility and the quotation for the following changes:

- squared top edge, instead of rounded
- unglazed top edge (on 12mm thickness the multilayer will be visible)
- bespoke sizes: please indicate X and Y in mm.

È possibile richiedere la fattibilità e la quotazione per le seguenti modifiche:

- top squadrato invece che arrotondato
- top non smaltato (nel 12mm sarà visibile il multilayer)
- misure non standard: indicare misura X e Y in mm

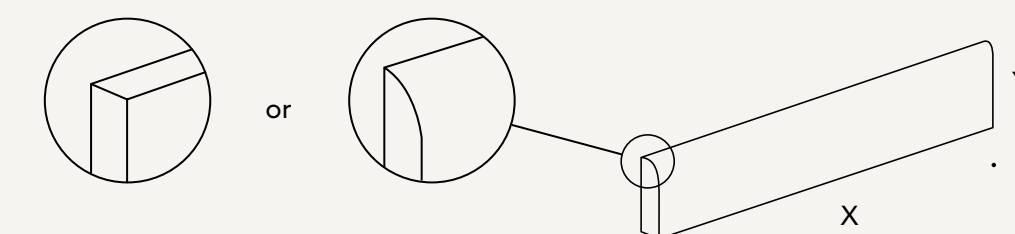

It is possible to request bespoke sizes on X, Y, Z and J. Minimum size 30mm, maximum 1900 for each variable. It is possible to ask for one or both sides closed, if the staircase is open. The piece can be made without nose, only at 90°. All sizes must be specified (A, B and C).

Le misure X, Y, Z e J sono modificabili a piacimento. Misura minima 30mm, massima 1900 per ogni variabile. È possibile richiedere il gradone con chiusura su un lato o su entrambi, nel caso la scala sia aperta. Il pezzo può essere realizzato anche a vela senza rientranza. È necessario indicare tutte le misure richieste (A, B e C).

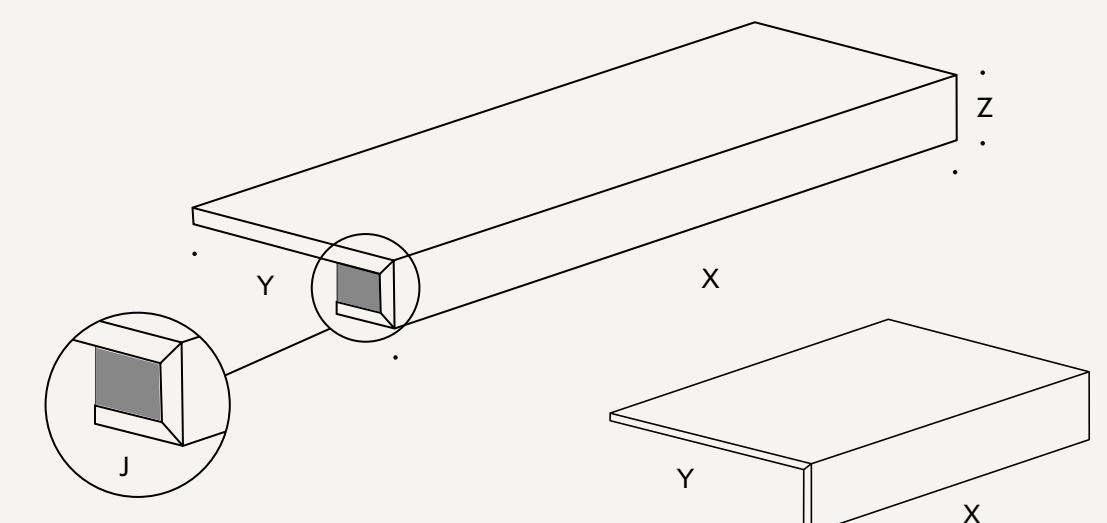

INTENDED USE CLASSIFICATION DESTINAZIONI D'USO

	NEW FLOORS PAVIMENTI NUOVE COSTRUZIONI	FLOOR RENOVATION PAVIMENTI IN RISTRUTTURAZIONI	WALL COVERING RIVESTIMENTI	LIGHT COMMERCIAL COMMERCIALE LEGGERO	HEAVY COMMERCIAL COMMERCIALE PESANTE	OUTDOOR ESTERNI	RAISED FLOOR SOPRELEVATO	COUNTERTOPS AND KITCHENTOPS PIANI DI LAVORO
12 mm	++	+	+	++	++	+	+	-
	floor tiling on screed in new buildings / posa a terra in nuove costruzioni su massetto	floor tiling on screed or on existing floor (in ceramic or natural stone) in buildings under renovation / posa a terra su pavimenti esistenti, in ceramica o pietra naturale, o su massetto in costruzioni in stato di ristrutturazione	wall covering / rivestimento muri	indoor public places subject to medium pedestrian traffic / ambienti pubblici interni a medio traffico	indoor public places subject to heavy pedestrian traffic / ambienti pubblici interni ad alto traffico	outdoor places / ambienti esterni	raised floor with floating structure or pvc supports / pavimenti sopraelevati con struttura flottante o posa su supporti in pvc	
	++ consigliato recommended + appropriato suitable - non consigliato not recommended -- non appropriato not suitable							

SHADE VARIATION INDEX INDICE DI STONALIZZAZIONE

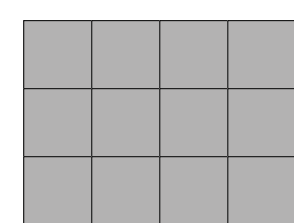

V1 / LOW
Monochromatic product
Prodotto monocromatico

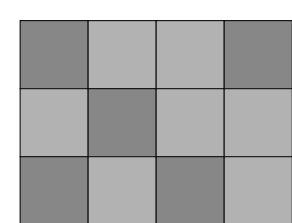

V2 / MODERATE
Product with light chromatic variation
Prodotto con leggera variazione cromatica

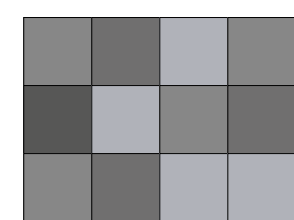

V3 / HIGH
Product with high chromatic variation
Prodotto con marcata variazione cromatica

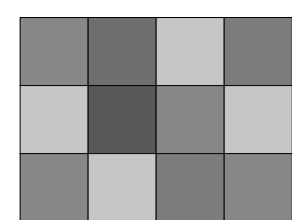

V4 / VERY HIGH
Product with very high chromatic variation
Prodotto con forte variazione cromatica

Surfaces / Superficie	Shade variation Stonalizzazione
Inclusioni Classico	V4

CALIBER CALIBRI

Our slabs are always rectified and the table below indicates their final size in millimetres. Our standard caliber is 09 and all sizes with the same caliber, when multiples, are modular with 2 mm joint spacing.

Le nostre lastre sono sempre rettificate e hanno dimensioni finali in millimetri come da tabella. Il caliber standard è lo 09 e i formati dello stesso caliber multipli tra loro sono modulari con 2 mm di fuga.

NOMINAL SIZE (CM) FORMATO NOMINALE (CM)	RECTIFIED SIZE (MM) FORMATO RETTIFICATO (MM)	CALIBER CALIBRO
120x250	1190x2500	09
120x120	1190x1190	09
60x120	594x1190	09
60x60	594x594	09
30x60	296x594	09
30x30	296x296	09

MODULARITY MODULARITÀ

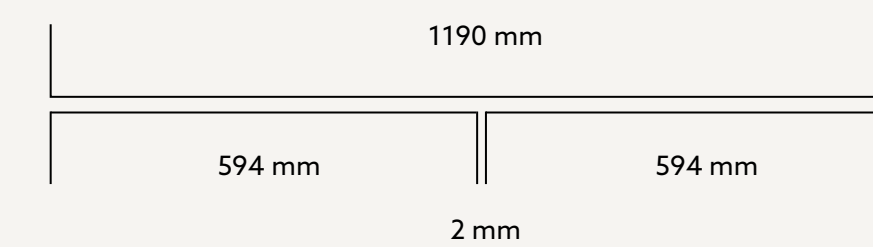

TECHNICAL SPECIFICATION CARATTERISTICHE TECNICHE

PORCELAIN SLABS / LASTRE DI GRES PORCELLANATO
ISO 13006 - G - BIA UGL (E ≤ 0,5%) UNI EN 14411 - G -

	TECHNICAL SPECIFICATIONS CARATTERISTICHE TECNICHE	STANDARD NORMA ISO	THICKNESS SPESSORE	INTERNATIONAL STANDARDS VALORI PRESCRITTI DALLE NORME	AVERAGE GIGACER VALUE / VALORE MEDIO GIGACER
	DIMENSIONAL CHARACTERISTICS CARATTERISTICHE DIMENSIONALI	ISO 10545-2	-	s > 410	
	SIDES LATI		-	± 0,6%	± 0,2%
	THICKNESS SPESSORE		-	± 5%	± 3%
	STRAIGHTNESS OF EDGES RETTILINEITÀ DEGLI SPIGOLI		-	± 0,5%	± 0,2%
	RECTANGULARITY ORTOGONALITÀ		-	± 0,6%	± 0,2%
	SURFACE FLATNESS PLANARITÀ	-	-	± 0,5%	± 0,2%
	WATER ABSORPTION ASSORBIMENTO D'ACQUA	ISO 10545-3	-	≤ 0,5%	≤ 0,1%
	BENDING STRENGTH RESISTENZA ALLA FLESSIONE	ISO 10545-4	≠ 12 mm	≥ 35 n/mm ²	≥ 40 n/mm ²
	MODULUS OF RUPTURE MODULO DI ROTTURA	ISO 10545-4	≠ 12 mm	> 1.300 n (sp. ≥ 7,5 mm)	≥ 4000 n
	RESISTANCE TO DEEP ABRASION RESISTENZA ALL'ABRASIONE PROFONDA	ISO 10545-6	-	≤ 175 mm ³	≤ 145 mm ³
	COEFFICIENT OF LINEAR THERMAL EXPANSION / COEFFICIENTE DI DILATAZIONE TERMICA LINEARE	ISO 10545-8	-	≤ 9X10 6°c 1	≤ 7X10 6°c 1
	RESISTANCE TO THERMAL SHOCKS RESISTENZA AGLI SBALZI TERMICI	-	-	AVAILABLE METHOD METODO DISPONIBILE	RESISTANT RESISTE
	FROST RESISTANCE RESISTENZA AL GELO	ISO 10545-12	-	AVAILABLE METHOD METODO DISPONIBILE	RESISTANT RESISTE
	RESISTANCE TO CHEMICAL ATTACKS RESISTENZA ALL'ATTACCO CHIMICO	ISO 10545-13	-	MIN. UB	RESISTANT RESISTE
	STAIN RESISTANCE RESISTENZA ALLE MACCHIE	ISO 10545-14	-	AVAILABLE METHOD METODO DISPONIBILE	RESISTANT RESISTE

We produce technical unglazed porcelain stoneware slabs, and some light impurities and dots must be considered as a standard feature of the product. / Trattandosi di un prodotto tecnico a solo impasto senza smalto alcune impurità e puntature visibili nei colori chiari sono da considerarsi una caratteristica tecnica del prodotto.

TECHNICAL NOTES NOTE TECNICHE

PORCELAIN SLABS - COEFFICIENT OF FRICTION / LASTRE DI GRES PORCELLANATO - COEFFICIENTE DI ATTRITO
ISO 13006 - G - BIA UGL (E ≤ 0,5%) UNI EN 14411 - G -

	SURFACES SUPERFICI	THICKNESS SPESSORE	DIN 51130	DIN 51097	BCR	BRITISH PENDULUM BS7976	R9729 UPI/ EMPA	DCOF (SECTION 9.6 ANSI A 137.1.2012)	
	INCLUSIONI CLASSICO	Mat	≠12 mm	R10	A+B*	> 0,40	PTV 36+	GS2/GB1	> 0,42 wet

*Average value / Valore medio

The values of slip resistance and of static and dynamic friction coefficient shown in the catalogue, and in the web site are merely indicative and non-binding. Any possible specific requirement must be confirmed by us at the order and anyway always before the installation. / I valori di resistenza allo scivolamento, coefficiente di attrito statico e dinamico, riportati sul catalogo e sul sito, sono da ritenersi puramente indicativi e non vincolanti. Ogni eventuale specifica necessità dovrà essere da noi confermata al momento dell'ordine e comunque sempre prima della posa.

All the information concerning use, installation, cutting, holes, joints, cleaning and maintenance are available on our website www.gigacer.it. / Tutte le informazioni relative a destinazione d'uso, posa, taglio, fori, giunti, pulizia e manutenzione sono disponibili sul nostro sito web www.gigacer.it.



PACKAGING IMBALLI

The cardboards used come from recycled sources 100%, and wood, fumigated according to ISPM-15, supports the weight of any pallet (gigacer pallets) stacked. It is important to stack only pallets of the same size. Gigacer assumes no responsibility for damages caused by incorrect handling of the material loading or unloading, unauthorized handling or accidents of any kind.

Il cartone utilizzato proviene al 100% da fonti riciclate e il legno, fumigato secondo le norme ISPM-15, sostiene il peso di eventuali pallet (sempre Gigacer) sovrapposti scaricandolo a terra. È importante sovrapporre i pallet dello stesso formato, e non euro pallet con pallet 120x120. Gigacer non si assume nessuna responsabilità per danni causati al materiale da errate manovre di carico o scarico, da movimentazioni non autorizzate o da eventi accidentali di qualsiasi tipo.

SIZE (CM) FORMATO	PALLET (CM)	PCS/BX PEZZI X COLLO	SQM/BX M ² X COLLO	KG/BX KG X COLLO	BX/PLT COLLI X PALLET	SQM/PLT M ² X PALLET	KG/PLT KG X PALLET
12 mm							
30 x 30 (Gigacer Service)	80x120	10	0,9	25,00	40	36,00	1015
30 x 60	120x120	4	0,72	20,20	72	51,84	1482
60 x 60	120x120	3	1,08	30,20	48	51,84	1482
60 x 120	120x120	2	1,44	40,30	36	51,84	1482
120 x 120	120x120	1	1,44	40,30	36	51,84	1482
costa retta step gradino costa retta 594 x 330 x 40 x 30	80x120	4	0,792	26,00	14	-	-
costa retta step gradino costa retta 1190 x 330 x 40 x 30	80x120	2	0,792	26,00	14	-	-
vela step / gradino vela 1190 x 300 x 180	124x137	1	0,36	17,00	-	-	-
skirting / battiscopa 594 x 71	80x120	10	6,00	12,00	60	-	-
12 mm full body							
120x250 rectified / rettificato	272x133xh42	1	3,00	84,00	12	36,00	1108
120x250 unrectified / non rettificato	272x133xh42	1	3,00	87,00	12	36,00	1144

CERTIFICATIONS CERTIFICAZIONI

GIGACER has achieved the process certifications ISO 9001:2015 e ISO 14001:2015. GIGACER has achieved the process certifications UNI EN 14411:2012. The quality of GIGACER products is constantly monitored with tests made by the main international certification laboratories.

GIGACER ha conseguito le certificazioni di processo ISO 9001:2015 e ISO 14001:2015. GIGACER ha conseguito le certificazioni UNI EN 14411:2012. La qualità dei prodotti GIGACER viene controllata costantemente tramite test effettuati dai principali laboratori ed enti di certificazione internazionali.



“Ceramics of Italy”

MADE IN ITALY
MADE IN FAENZA

Does not damage with chemical detergents anticovid. / Non si danneggia con i detergenti chimici anticovid.

Real colours and decorations might slightly differ from those depicted in this catalogue. / Quanto contenuto nel catalogo è puramente indicativo riguardo a colori e decorazioni.

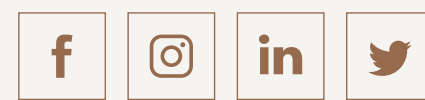

GIGACER S.P.A.
via Caltagirone, n.72 / 48018 Faenza (RA) ITALY
Tel. +39 0546 637 111 / Fax +39 0546 637 127
info@gigacer.it
gigacer.it

